

M12 male 90° / M12 female 90° CANopen/DeviceNet

PUR AWG24+AWG22 shielded vt UL/CSA+drag ch. 2m

DeviceNet, CANopen

Male 90° – female 90°

M12 – M12, 5-pole

shielded

Plastic housings with good resistance against chemicals and oils.

The resistance to aggressive media should be individually tested for your application. Further details on request.

Further cable lengths on request.

Illustration

stay connected

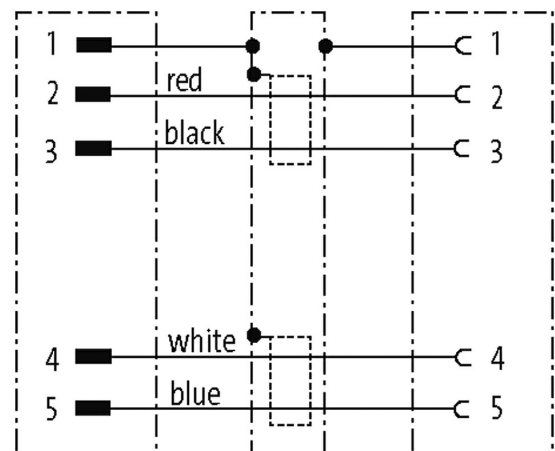
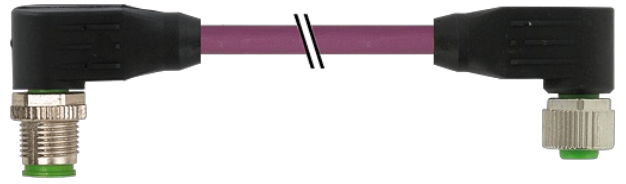

Product may differ from Image

Approvals

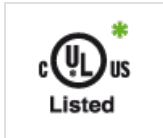

cCSAus

* only for products with UL/CSA approved cable

EAC

More Info

DeviceNet

CANopen

Form

Form 40551

Cables

No./diameter of wires	2 × 0.25 + 2 × 0.34 mm ²
Wire isolation	PE (rd, bk), (bl, wh)
Material (jacket)	PUR (UL/CSA)
Outer Ø	6.9 mm ±5%
Bend radius (moving)	10 × outer Ø
Temperature range (fixed)	-40...+80 °C
Temperature range (mobile)	-30...+70 °C
Cable identification	803
Approval (cable)	UL (AWM-Style 20233/10578), CSA; CE
Cable weight [g/m]	63,12
Material (wire)	Cu wire, tin plated
Resistor (core)	max. 78 Ω/km (data pair, max. 54 Ω/km (power pair); (20 °C)
Diameter (core)	2 × 0.25 + 2 × 0.34 mm ²
AWG	similar to AWG 24 (0.25 mm ²); similar to AWG 22 (0.34 mm ²)
Wire-Ø incl. isolation	2.1 mm ±5% (0.25 mm ²); 1.5 mm ±5% (0.34 mm ²)
Color/numbering of wires	wh, bl (data pair); bk, rd (power pair)
Shield	yes
	min. 65%
Material (jacket)	PUR
Outer-Ø (jacket)	6.9 mm ±5%
Color (jacket)	violet
chemical resistance	good resistance to oil, gasoline and chemicals
thermal resistance	flame retardant
Nominal voltage	300 V
Temperature range (fixed)	-40...+80 °C
Temperature range (mobile)	-30...+70 °C
Bend radius (fixed)	6 × outer Ø
Bend radius (moving)	10 × outer Ø
Traversing distance (C-track)	max. 5 m (horizontal)
Travel speed (C-track)	max. 3 m/s
Acceleration (C-track)	max. 5 m/s ²
Jacket Color	violet

Technical Data

Operating voltage	max. 60 V AC/DC
Operating voltage (only UL listed)	max. 30 V AC/DC
Operating current per contact	max. 4 A
Locking of ports	Screw thread (M12×1 mm) recommended torque 0.6 Nm, self-securing

Locking material	Zinc die casting, matte nickel plated
Protection	IP65, IP66K, IP67 inserted and tightened (EN 60529)

General data

Temperature range	-25...+85 °C, depending on cable quality
-------------------	--

Commercial data

country of origin	CZ
customs tariff number	85444290
EAN	4048879164535
eClass	27061801
Packaging unit	1

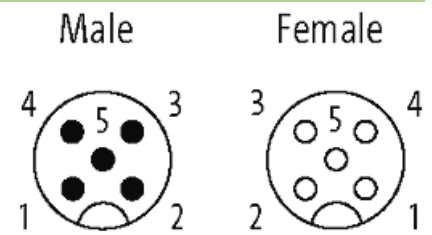
Sketch

Product may differ from Image